

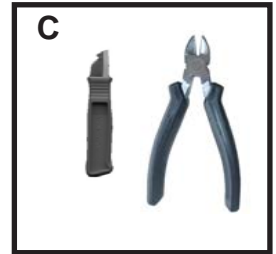

INSTALLATION INSTRUCTIONS

... B1/4X & ...BL1/4X CONNECTORS.



	NM - NF	7/16M	7/16F
	2 x 16mm + 19mm	16mm + 21mm + 27mm	16mm + 21mm

CABLE PREPARATION

A + B

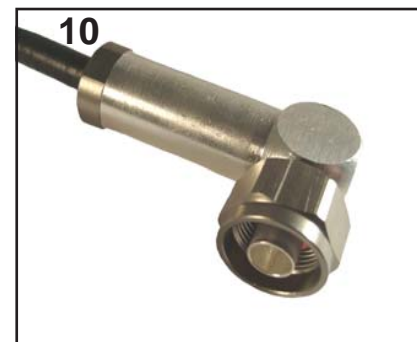
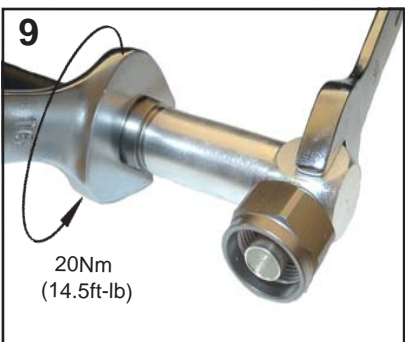
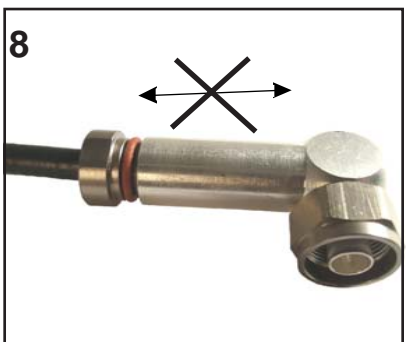
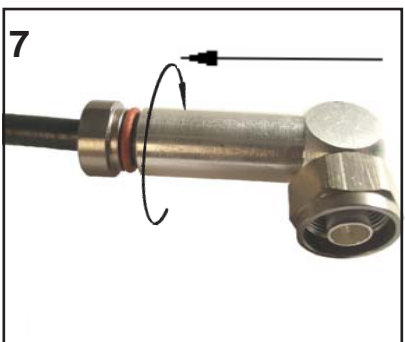
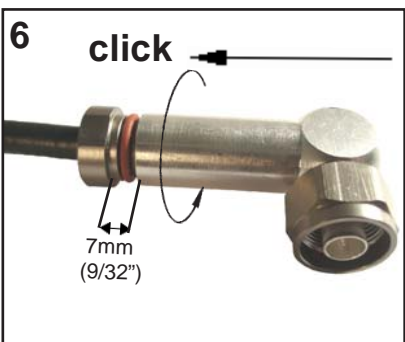
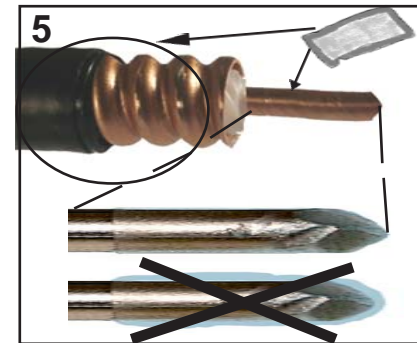
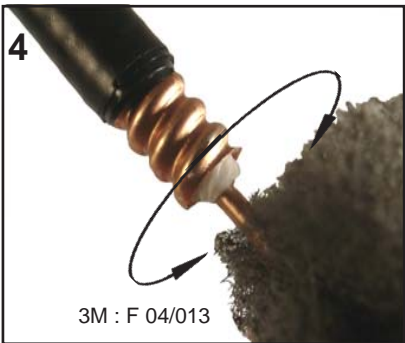
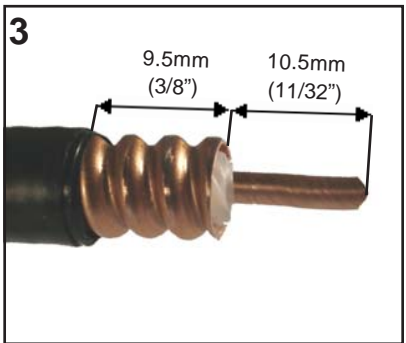
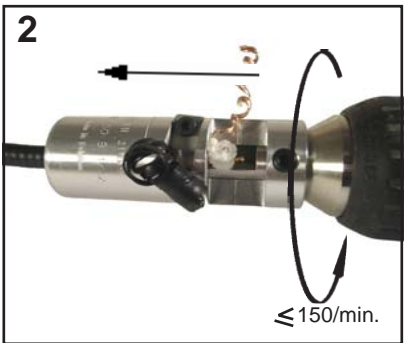
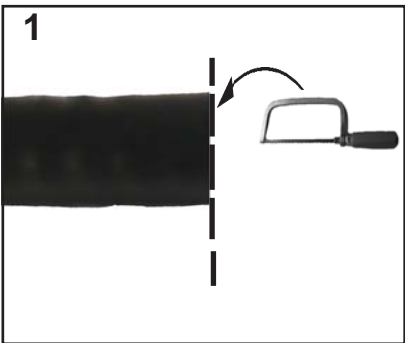

B + C

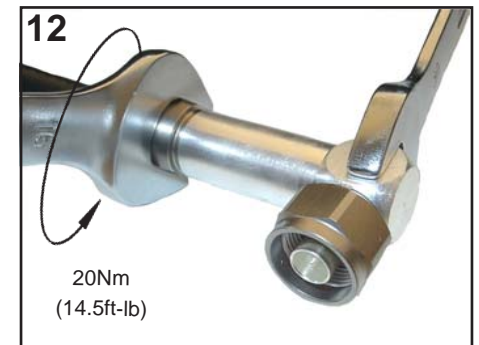
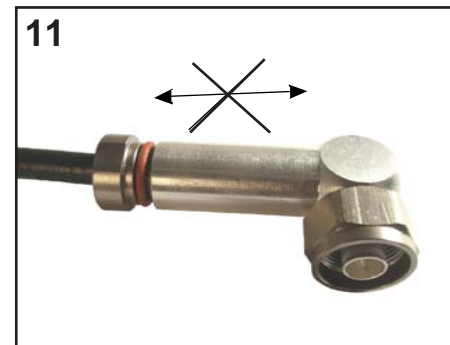
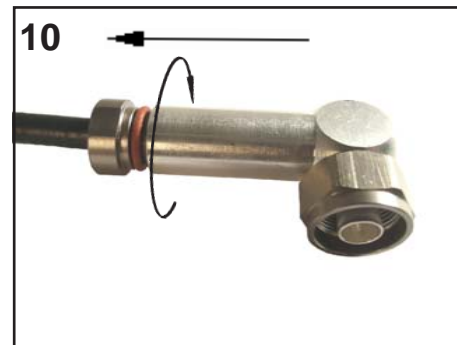
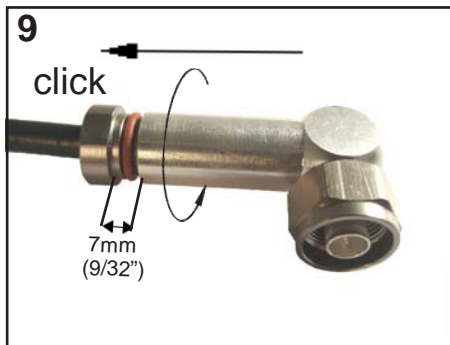
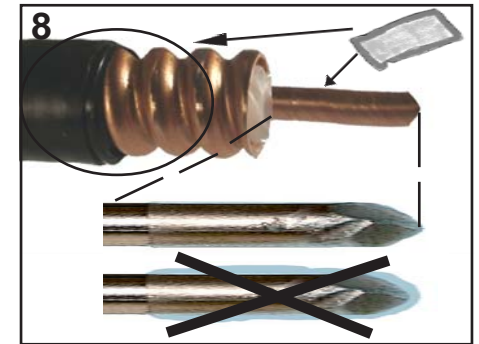
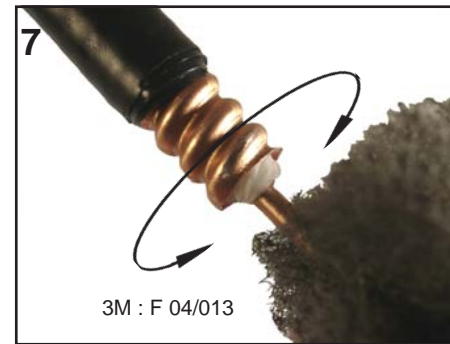
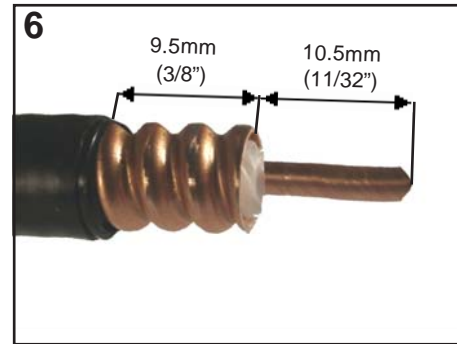
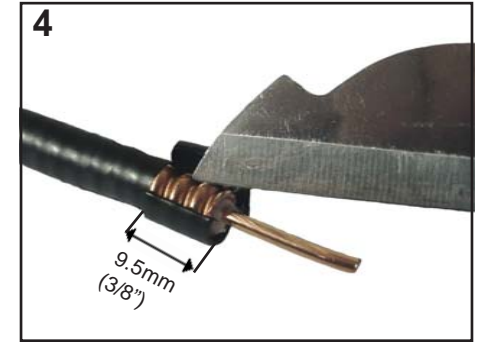
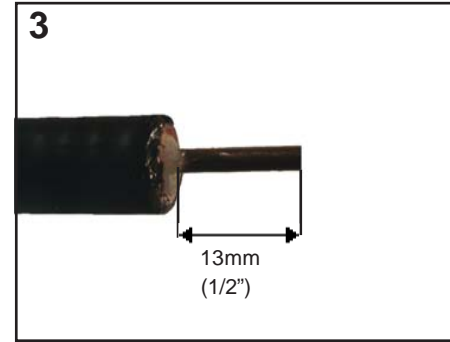
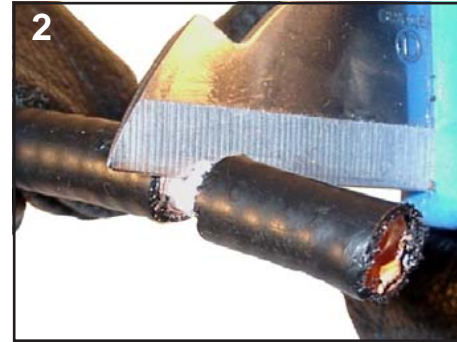
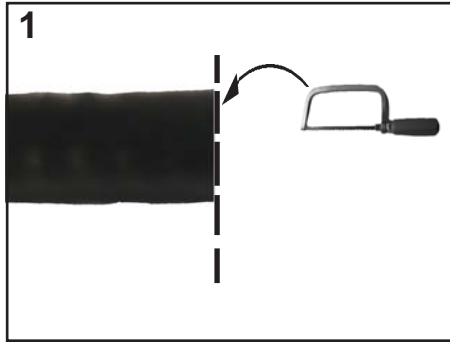

AVIS
KABELWERK EUPEN AG
décline toute responsabilité en cas
de non respect de ces instructions.

NOTICE
KABELWERK EUPEN AG dis-
claims any liability or responsibility
for the results of improper or un-
safe installation practices.

AVISO :
KABLEWERK EUPEN AG
rehusa todas las
responsabilidades en caso de no
respetar las instrucciones.

WAARSCHUWING
KABELWERK EUPEN AG wijst
elke verantwoordelijkheid van
de hand in geval van het niet
opvolgen van deze
aanbevelingen.

BEMERKUNG
KABELWERK EUPEN AG
lehnt jede Verantwortung bei
Nichtbeachtung dieser
Instruktionen ab.

注意：
本公司声明对于不恰当或不
安全的安装，检验，维修或拆
卸操作所导致的后果不负任
何义务和责任。